

**** For optimum performance the ventilator should be installed on a flat surface free from defects ****

Fixing Instructions

1. Prepare slots accurately and pre-drill fixing holes. Avoid glazing rebates and reinforcement.

Recommended screws: 3.5mm (No.6) Round Head or equivalent.

Fitting Tolerance: Due to the SF Xtra vent being designed for narrow profiles, the accuracy of fitting is vital to achieve best performance. The screws must be fitted on the same centre line as the slot, with maximum tolerances of 0.5mm above and 1mm below the centre line.

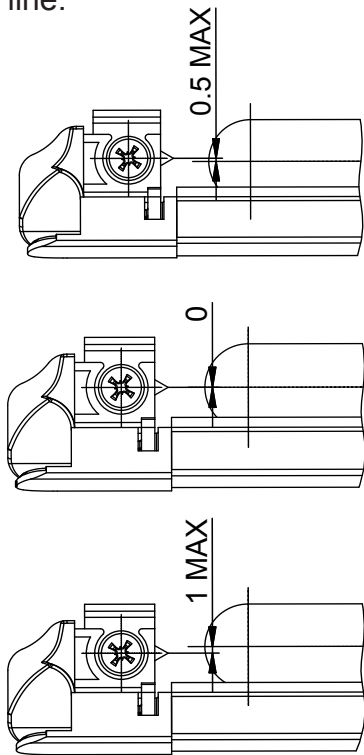

2. Fix vent by opening end caps and screwing to section. **DO NOT OVERTIGHTEN SCREWS!**

End caps should be delivered closed but not clicked shut. If they click shut during transit they can be opened again by gently rotating a flat blade screwdriver as shown below.

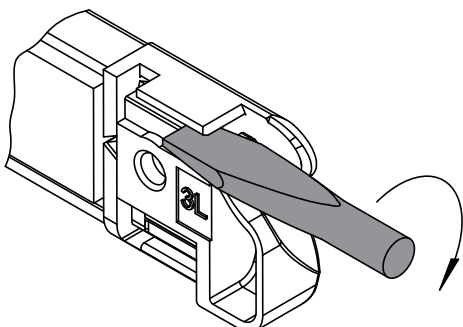

Operating Instructions

Open Ventilator at either end by levering open under end cap.

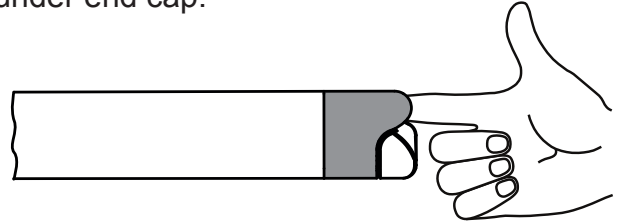



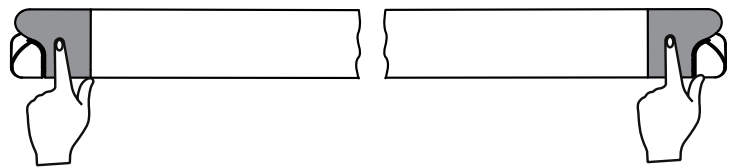



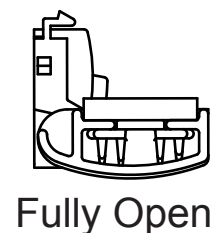
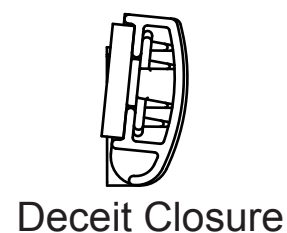
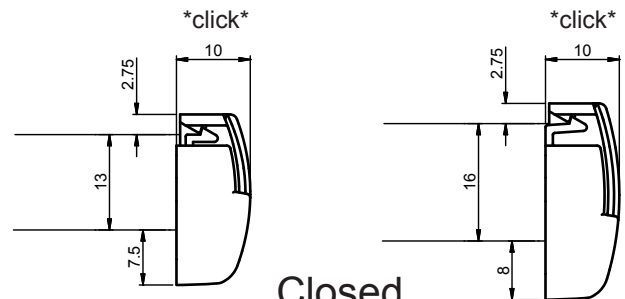

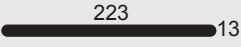

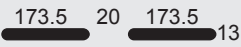
Close Ventilator by pressing vent at both ends until both 'click'.

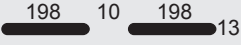

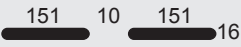
The SF Xtra ventilator allows the user to select the following projections for complete control:

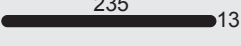

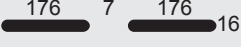
Slot Details				
Product	Ventilation Performance (mm ²)	Overall Length (mm)	Fixing Centres (mm)	Slot Size (mm)
SFX 13 2500EA Vent 294mm	2500EA	294	260	
SF318 Canopy		318	300	
XC13 267 Canopy				
SFX 13 2500EA vent 253mm	2500EA	253	219	
SFX 205 Plastic clip fix canopy		203		
SFX 13 4000EA Vent 434mm	4000EA	434	400	
SF441 Canopy		441	423	
XC13 412 Canopy		411	387	
SFX 13 5000EA Vent* 400mm	5000EA	400	366	
SFX 13 5000EA Vent 465mm	5000EA	465	431	
SFX418 Plastic Clip Fix Canopy		418		
SFX 13 5000EA Vent 529mm	5000EA	529	495	
SF528 Canopy		528	510	
XC13 497 Canopy		497	473	
SFX 16 4000EA Vent 374mm	4000EA	374	340	
HF404 Canopy		404	385	
XC16 364 Canopy		364	339	
SFX 16 5000EA Vent 509mm	5000EA	509	475	
HF 529 Canopy		529	510	
SFX 13 2500EA Vent 294mm	2500EA	294	260	
SF318 Canopy		318	300	
SFX 13 5000EA Vent 529mm	6000 Free Area	529	495	
TV4000 575 Canopy		575	560	
SFX 16 Vent 419mm	5500 Free Area	419	385	
TV90 425 Canopy		425	415	

*This vent is designed for use where no protection from weathering required or for ventilation of a habitable room through another room or conservatory.