

EU DECLARATION OF CONFORMITY

Product HRV1.6 Q Plus EcoAura
Part Number TP419B-LH
Manufacturer Titon Hardware Limited
Address 894 The Crescent, Colchester Business Park, Colchester, Essex, CO4 9YQ, UK.

This declaration of conformity is issued under the sole responsibility of the manufacturer.

Product Type Mechanical Heat Recovery Ventilation Unit

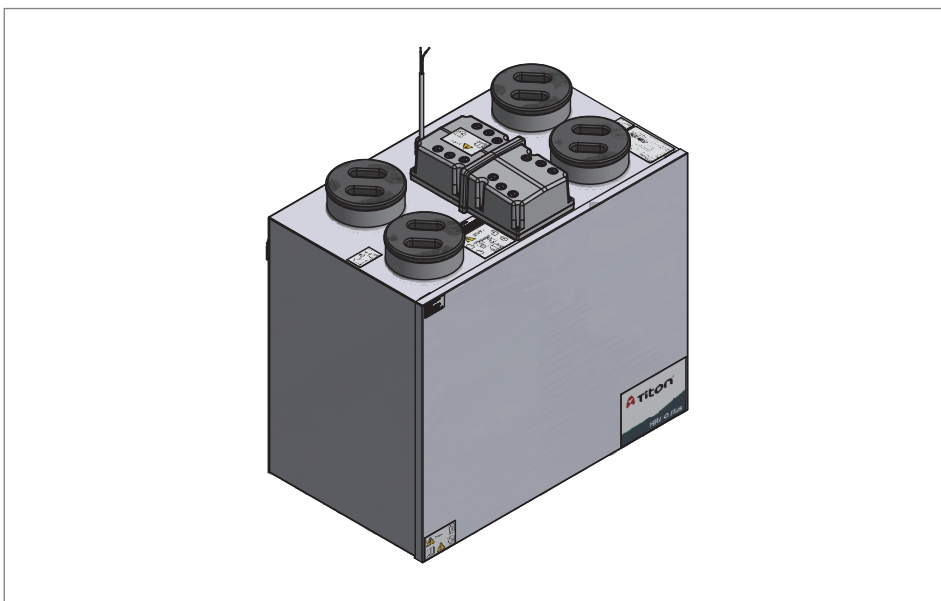

This object of the declaration described above is in conformity with the relevant Union harmonised legislation:

Harmonised legislation:

1253/2014 Ecodesign
1254/2014 Energy Labelling
2014/35/EU Low Voltage
2014/30/EU Electromagnetic Compatibility
2012/19/EU Waste Electrical and Electronic Equipment

Harmonised Standards:

BS EN 13141-7
BS EN 55014-1
BS EN 55014-2
BS EN 60335-1
BS EN 60335-2-80
BS EN 61000-3-2
BS EN 61000-3-3

Signed for and on the behalf of:

Titon Hardware Limited
894 The Crescent, Colchester Business Park, Colchester, Essex, CO4 9YQ, UK.

Date:

20th September 2021



Mat Norris
Chief Executive



Lionel Holmes BSc (Hons) CEng MIET
Operations Director



Paul S Cowell BEng (Hons) CEng MCIBSE
Technical Director