

DECLARATION OF CONFORMITY

Product HRV1.35 *Q Plus* Eco HMB
Part Number TP408HMB-544-T
Manufacturer Titon Hardware Limited
Address 894 The Crescent, Colchester Business Park, Colchester, Essex, CO4 9YQ, UK.

This declaration of conformity is issued under the sole responsibility of the manufacturer.

Product Type Mechanical Heat Recovery Ventilation Unit

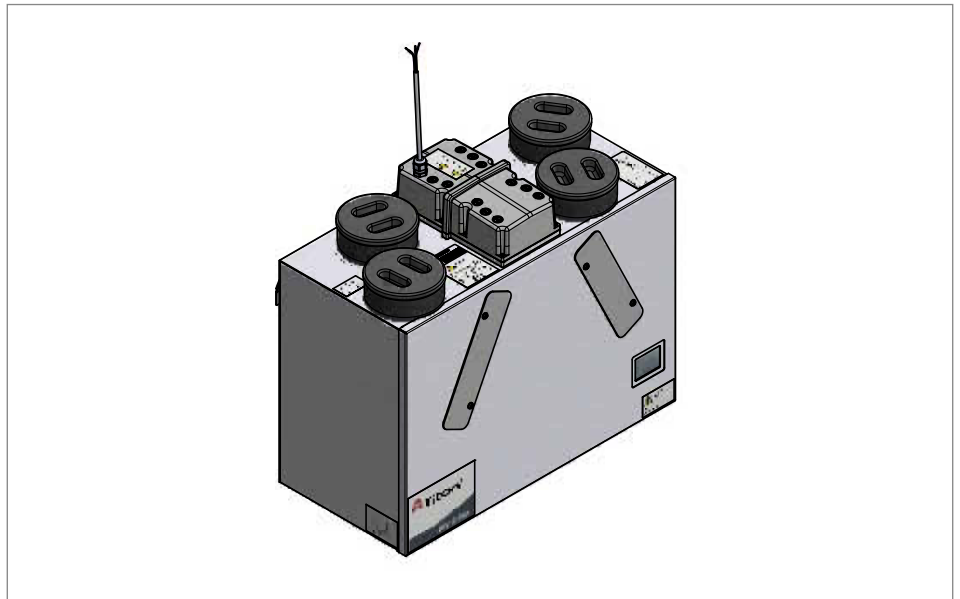

This object of the declaration described above is in conformity with the relevant legislation:

Legislation:

SI 2015/469 Ecodesign
SI 2016/1101 Electrical Equipment (Safety)
SI 2016/1091 Electromagnetic Compatibility
Waste Electrical and Electronic Equipment
SI 2012/3032 Restriction of the Use of Certain Hazardous Substances

Standards:

BS EN 13141-6
BS EN 55014-1
BS EN 55014-2
BS EN 60335-1
BS EN 60335-2-80
BS EN 61000-3-2
BS EN 61000-3-3
BS EN IEC 63000

Signed for and on the behalf of: Titon Hardware Limited
894 The Crescent, Colchester Business Park, Colchester, Essex, CO4 9YQ, UK.

Date: 16th December 2022



Alexandra French
Chief Executive



Paul Tarling
Operations Director



Paul S Cowell BEng (Hons) CEng MCIBSE
Technical Director